

## PD10 and PD100F Snow Guard Installation Instructions

### Typical Roof Types:

- New slate (shown)
- New synthetic slate
- New composition shingle
- New cedar shingle

### Installation:

1. Install the first 3 rows of slate, and place the strap of the snow guard on the roof deck (*fig. A*).
2. Place the snow guard low enough on the slate to leave a minimum gap of 5/8", or at least 3 times the thickness of the slate, whichever is greater, from the slate above (*fig. B*).
3. To attach the snow guard, use a minimum of 2 fasteners of a material compatible with the snow guard and the roof system.

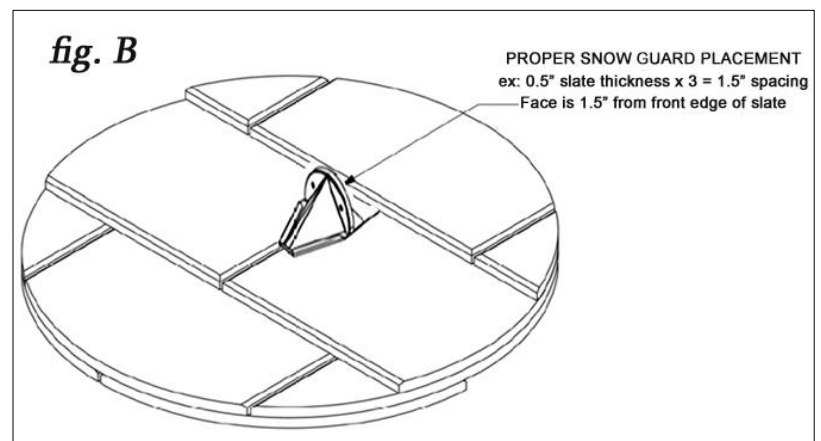
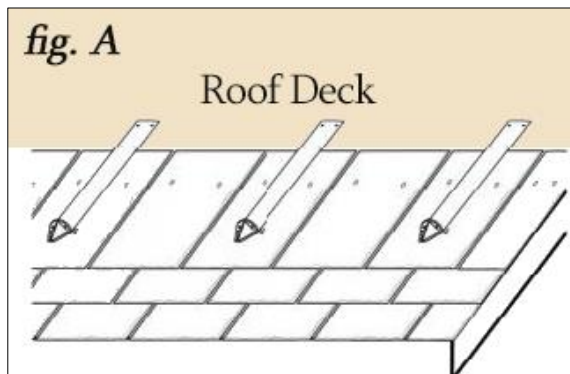

## Standard Snow Guard Layout Options

**IMPORTANT:** All layouts begin with a 3-row pattern. Estimated quantities provided include 3-row pattern. If you have any questions, please contact us at 888-766-4273.

Please use the guidelines below to determine the appropriate layout for your installation.

Layout	Rafter Length	Ground Snow Load (psf)	Roof Pitch	Est. Snow Guard Qty	Spacing
3-Row Pattern	15' or less	75 psf or less	16/12 or less	17 per 10' of eave	3 rows, 24" on center horizontally with the middle row staggered 12"
2x4 Pattern	15' or greater	75 psf or less	16/12 or less	12 per roofing square	Space rows 2' vertically and 4' horizontally to within 10' of the ridge
2x3 Pattern	Any	75-110 psf	16/12 or less	18 per roofing square	Space rows 2' vertically and 3' horizontally to within 10' of the ridge
2x2 Pattern	Any	111-150 psf	16/12 or less	24 per roofing square	Space rows 2' vertically and 2' horizontally to within 10' of the ridge

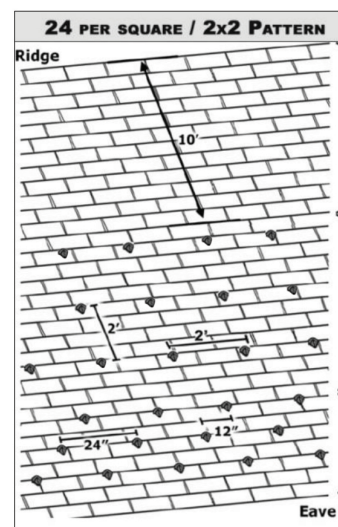
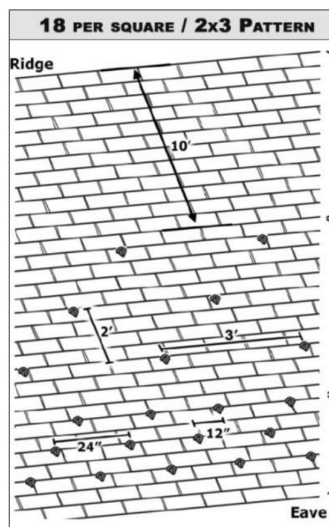
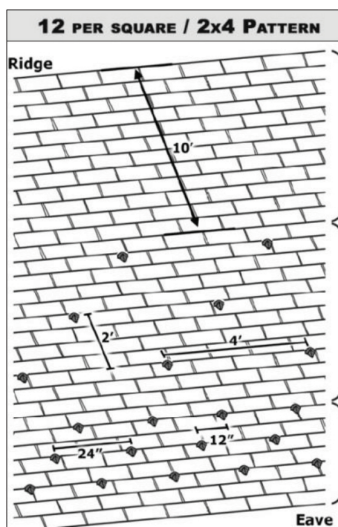
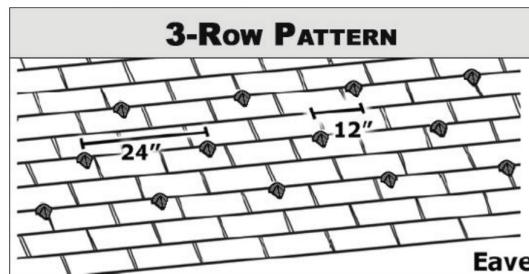

Document Version 09.21.2020  
07 72 53 Snow Guards

